



Gas sensor KSIM 1530

for detection of R404a



Features

- The gas detector measures the selected gas concentration
- The gas detector is part of the digital KIMESSA CANline BUS-Network which is designed for up to 128 gas detectors and alarming units
- linearized and temperature-compensated digital CANline-BUS output signal
- 16...30 VDC supply voltage (4-wire cable)
- various gas sensor technologies available (electrochemical, Infrared, pellistor, semiconductor)
- factory calibration with calibration certificate to the specified measuring range
- Zero & Span potentiometers and calibration jack socket accessible from outside without opening the gas detector enclosure
- water- and dust-proof IP 65 enclosure
- rust-proof and acid-resistant steel enclosure
- Swiss-Made

Gas sensor KSIM 1530

Gas:	Freon R134a/R404a/R407c, etc
Gas formula:	R134a/R404a/R407c, etc
Warranty:	12 month warranty
Position:	30 cm from Floor

Sensor specifications

Measurement principle:	Infrared
Measuring range:	0...10'000 ppm
Standard calibration:	0...2500/5000/10'000 ppm
Response time t_{90} :	< 90 sec
Operating temperature:	-30 °C ... +50 °C
Start up after reconditioning:	approx. 1 hour
Pressure range:	atmospheric \pm 10%
Air humidity:	15...90 % R.H. non-condensing
Position sensitivity:	none
Long term output drift:	< 2% signal loss/month
Life span at 20 °C:	6-8 years, depending on the application

Electronic and Dimensions

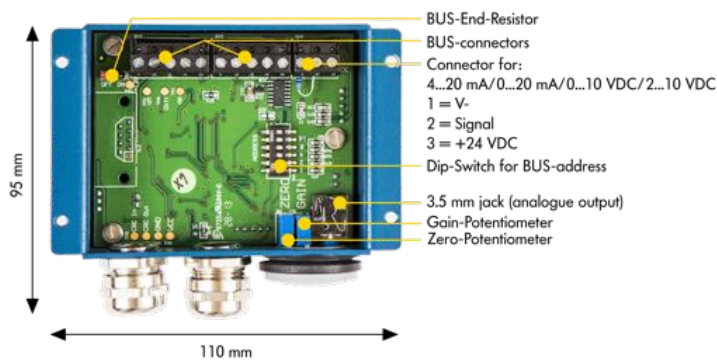

Housing

Housing protection:	IP 65
Material:	rust-proof and acid-resistant
Weight:	550 g

Specifications electronic

Wiring analogue:	3x 0,75 mm ² , shielded
Wiring digital:	4x 1,0 mm ² , shielded
Supply:	16.5...30 VDC
Power consumption:	max. 80 mA
Output signal analogue:	4...20 mA / 0...20 mA
Output signal digital:	KIMESSA CANBUS
Switching output:	no

Specifications construction

Cable gland:	1x M16 (digital 2x M16)
Cable entry:	bottom
Tests:	CE
Display:	no
Position:	position independent

Inspection (Maintenance)

The sensor and the electronic require an inspection. Routine calibration is recommended once or twice a year.

